

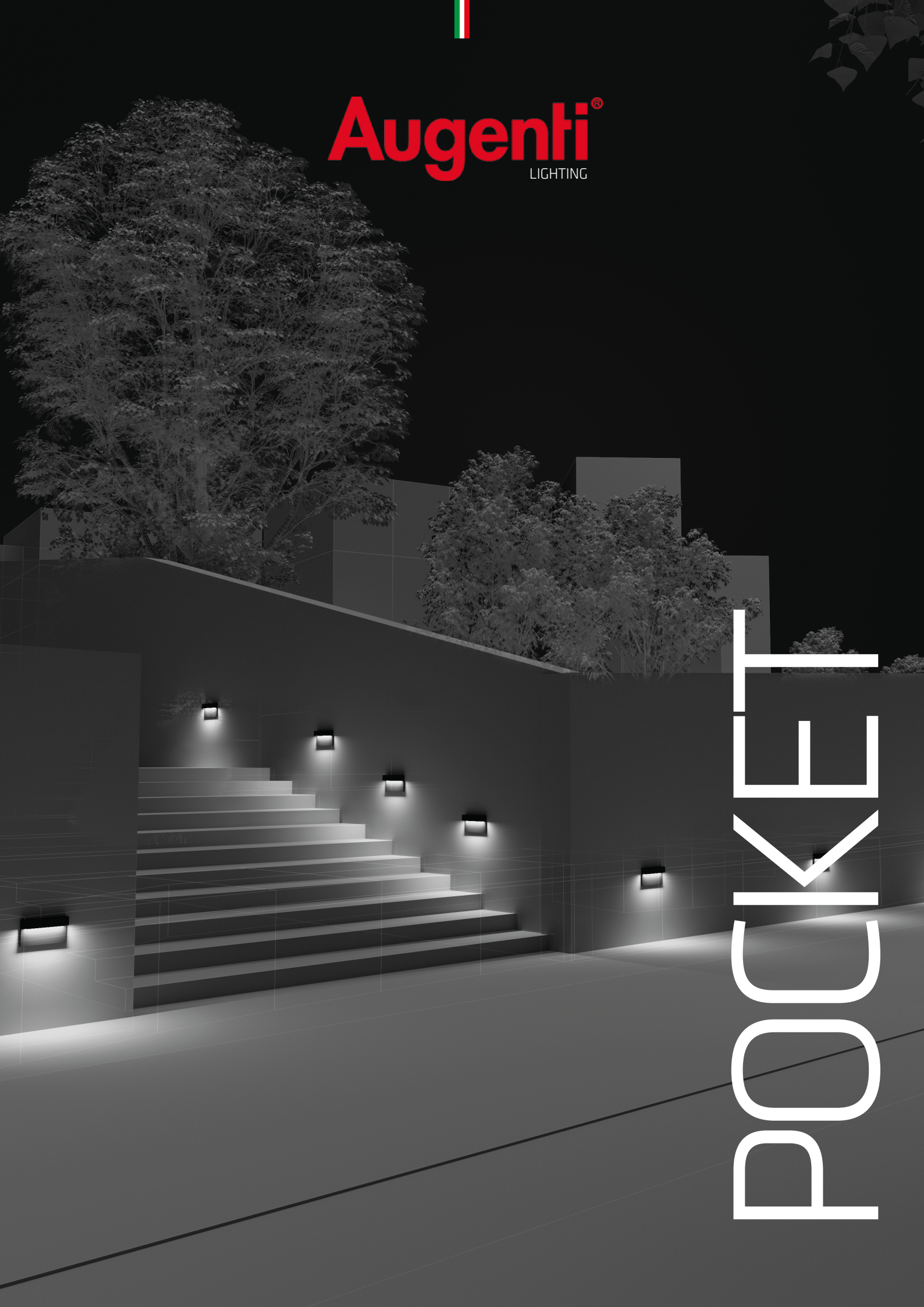



**Augenti**<sup>®</sup>  
LIGHTING



# POCKET





IN THE  
REALM OF  
DREAMS,  
LIGHT IS THE  
STORYTELLER

**POCKET** collection

# POCKET collection

**Pocket**, la nuova linea di segnapasso per esterno, è stato concepito con un occhio attento alla cura del dettaglio. Riconosciamo che ogni spazio è unico, motivo per cui Pocket è disponibile in tre dimensioni diverse: sia che si tratti di illuminare un giardino, un vialetto o un percorso pedonale, la nostra gamma soddisfa tutte le esigenze. La sua forma compatta non compromette la sua efficacia. Oltre alla sua **estetica accattivante**, la nostra linea di segnapasso offre **funzionalità avanzate** per migliorare la vostra esperienza all'aperto. Può essere agevolmente fissato alla comune scatola di derivazione elettrica o installato in superficie.

**Pocket**, the new outdoor step light line, has been conceived with an eye to detail. We recognize that each space is unique, which is why **Pocket** is available in three different sizes: whether it is lighting a garden, a driveway or a pedestrian path, our range meets all needs. Its compact shape does not compromise its effectiveness. In addition to its **eye-catching aesthetic**, our line of step light offers **advanced features** to enhance your outdoor experience. It can be easily fixed to the traditional electrical junction box or installed on the surface.

**Pocket**, la nouvelle ligne d'encastres muraux pour extérieur, a été conçue avec un souci du détail. Nous reconnaissons que chaque espace est unique, c'est pourquoi **Pocket** est disponible en trois tailles différentes: qu'il s'agisse d'éclairer un jardin, une allée ou un sentier piétonnier, notre gamme répond à tous les besoins. Sa forme compacte ne compromet pas son efficacité. En plus de son **esthétique attrayante**, notre ligne encastrée offre des **fonctionnalités avancées** pour améliorer votre expérience de plein air. Il peut être facilement fixé à la boîte de jonction électrique traditionnelle ou installé en surface.

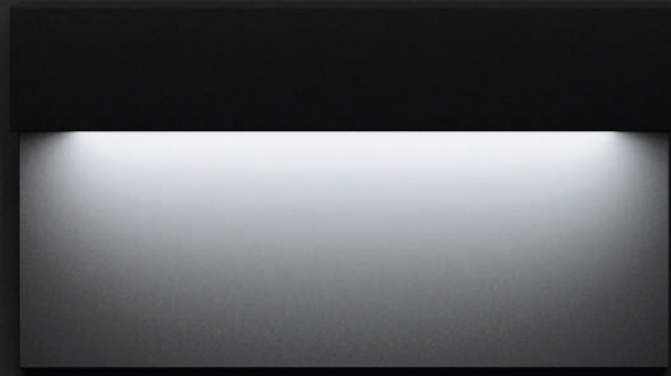

# POCKET

collection

**Augenti**<sup>®</sup>

3/pocket WALL RECESSED

# Fixture Specifications

Protection . IP 65 - IK 07

Body . Die-cast aluminium

Screen . Pointed Glass

Seals . Molded silicone gasket UV Resist

Screws . Stainless steel A2

Paint / Finishing . Anti-corrosive UV stabilised polyester powder



## Finishes



00

PURE WHITE  
RAL 9016

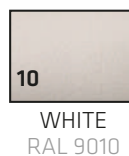

10

WHITE  
RAL 9010

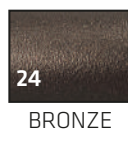

24

BRONZE

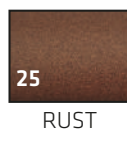

25

RUST

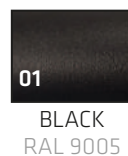

01

BLACK  
RAL 9005

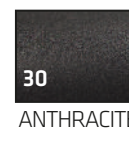

30

ANTHRACITE

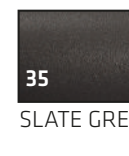

35

SLATE GREY



40

GREY  
RAL 9006



55

GREEN COOL  
MINT  
RAL 6019

New Color

## Technical Data

2700K - 3000K - 4000K

**Versione in Tensione - Constant voltage (Vdc)**

2W con DRIVER REMOTO 24Vdc - 2W REMOTE DRIVER 24Vdc

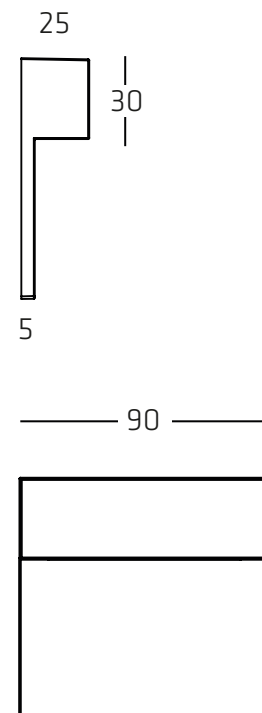

## Specifications





# POCKET 90

led WHITE

Versione in Tensione - Constant voltage (Vdc)

LED SYSTEM WITH REMOTE DRIVER 24V

code	beam	class	power	W	source	fixture	CCTLED	CRI
<b>9200R</b> /HRRCVT	 DIFFUSE	III	24Vdc	2	280 lm	160 lm	2700K	80
<b>9200R</b> /WRRCVT	 DIFFUSE	III	24Vdc	2	280 lm	160 lm	3000K	80
<b>9200R</b> /NRRCVT	 DIFFUSE	III	24Vdc	2	280 lm	160 lm	4000K	80



## Accessories

informazioni sugli accessori sul nostro sito web  
information about accessories on our website

Recessed Box 502

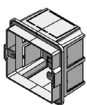

DRIVER 24Vdc

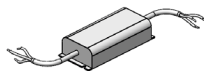

HUB for electronic parts

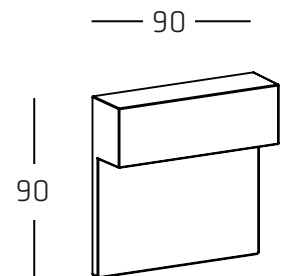

Quote espresse in millimetri "mm"  
Share expressed in millimeters "mm"

Sizes . H90 x L90

## Specifications



website-link

5/pocket WALL RECESSED

# Fixture Specifications

Protection . IP 65 - IK 07

Body . Die-cast aluminium

Screen . Pointed Glass

Seals . Molded silicone gasket UV Resist

Screws . Stainless steel A2

Paint / Finishing . Anti-corrosive UV stabilised polyester powder

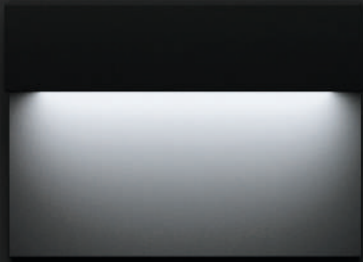

## Finishes

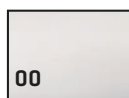

00  
PURE WHITE  
RAL 9016

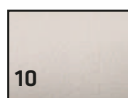

10  
WHITE  
RAL 9010

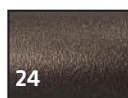

24  
BRONZE

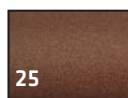

25  
RUST

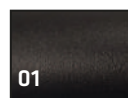

01  
BLACK  
RAL 9005

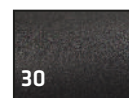

30  
ANTHRACITE

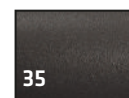

35  
SLATE GREY

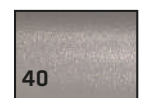

40  
GREY  
RAL 9006

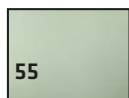

55  
GREEN COOL  
MINT  
RAL 6019

New Color

## Technical Data

2700K - 3000K - 4000K

Versione in Tensione - Constant voltage (Vdc)

4W con DRIVER REMOTO 24Vdc - 4W REMOTE DRIVER 24Vdc

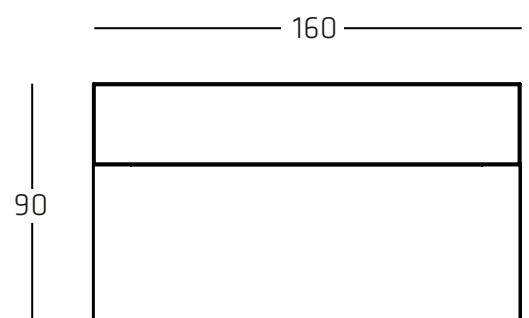
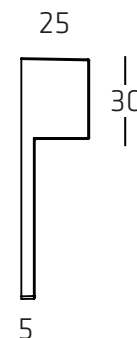

## Specifications







# POCKET 160

led WHITE

## Versione in Tensione - Constant voltage (Vdc)

## LED SYSTEM WITH REMOTE DRIVER 24V

code	beam	class	power	W	source	fixture	CCT LED	CRI
<b>9201R</b> /HRRCVT	 DIFFUSE	III	24Vdc	4	560 lm	310 lm	2700K	80
<b>9201R</b> /WRRCVT	 DIFFUSE	III	24Vdc	4	560 lm	310 lm	3000K	80
<b>9201R</b> /NRRCVT	 DIFFUSE	III	24Vdc	4	560 lm	310 lm	4000K	80

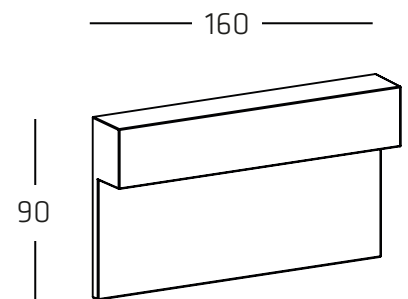

## Accessories

informazioni sugli accessori sul nostro sito web  
information about accessories on our website

Recessed Box 503/504

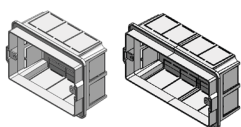

DRIVER 24Vdc

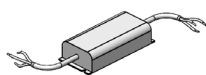

HUB for electronic parts



Quote espresse in millimetri "mm"  
Share expressed in millimeters "mm"

Sizes . H90 x L160

## Specifications



website-link

# Fixture Specifications

Protection . IP 65 - IK 07

Body . Die-cast aluminium

Screen . Pointed Glass

Seals . Molded silicone gasket UV Resist

Screws . Stainless steel A2

Paint / Finishing . Anti-corrosive UV stabilised polyester powder

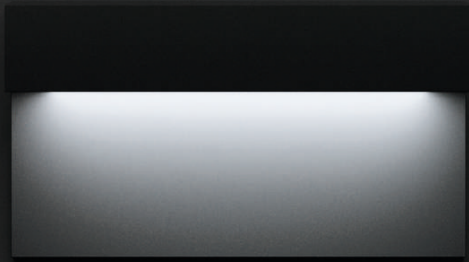

## Finishes

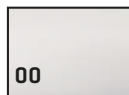

00  
PURE WHITE  
RAL 9016

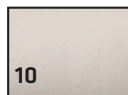

10  
WHITE  
RAL 9010

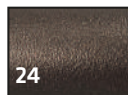

24  
BRONZE

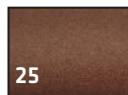

25  
RUST

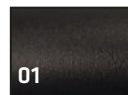

01  
BLACK  
RAL 9005

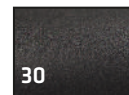

30  
ANTHRACITE

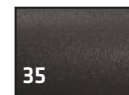

35  
SLATE GREY

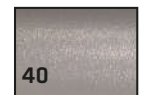

40  
GREY  
RAL 9006

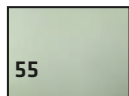

55  
GREEN COOL  
MINT  
RAL 6019

New Color

## Technical Data

2700K - 3000K - 4000K

Versione in Tensione - Constant voltage (Vdc)

6W con DRIVER REMOTO 24Vdc - 6W REMOTE DRIVER 24Vdc

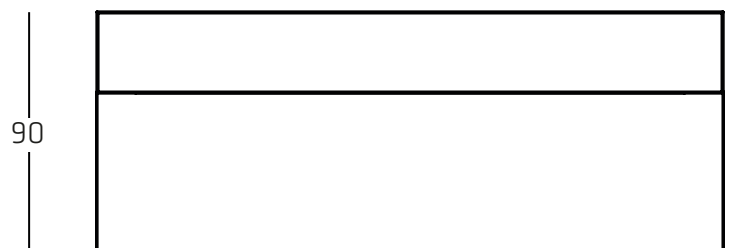
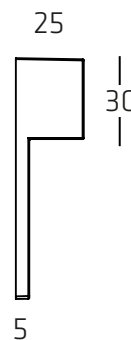

## Specifications





# POCKET 230

led WHITE

## Versione in Tensione - Constant voltage (Vdc)

## LED SYSTEM WITH REMOTE DRIVER 24V

code	beam	class	power	W	source	fixture	CCTLED	CRI
<b>9202R</b> /HRRCVT	 DIFFUSE	III	24Vdc	6	840 lm	460 lm	2700K	80
<b>9202R</b> /WRRCVT	 DIFFUSE	III	24Vdc	6	840 lm	460 lm	3000K	80
<b>9202R</b> /NRRCVT	 DIFFUSE	III	24Vdc	6	840 lm	460 lm	4000K	80

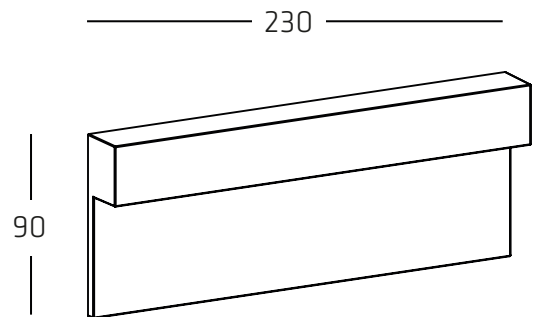
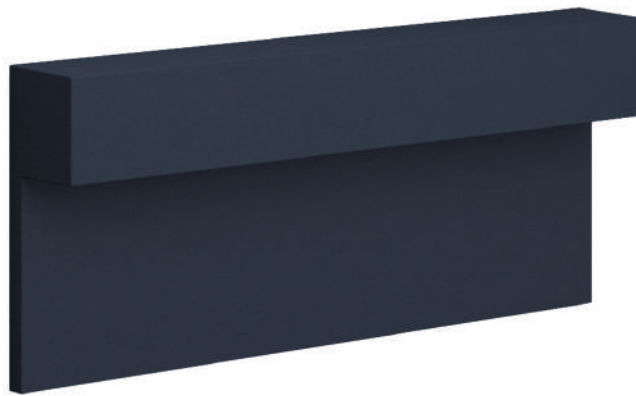

## Accessories

informazioni sugli accessori sul nostro sito web  
information about accessories on our website

Recessed Box 503/504

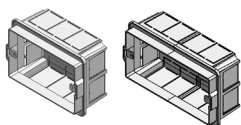

DRIVER 24Vdc

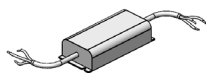

HUB for electronic parts



Quote espresse in millimetri "mm"  
Share expressed in millimeters "mm"

Sizes . H90 x L230

## Specifications



website-link

# POCKET light diffusion

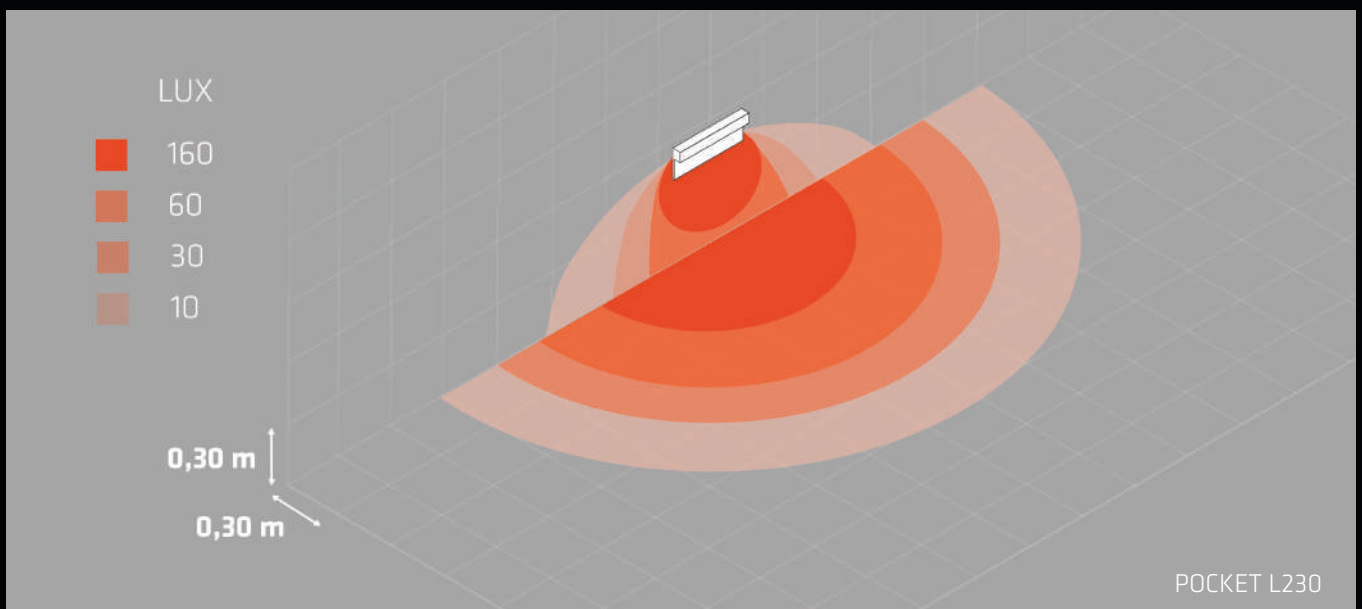
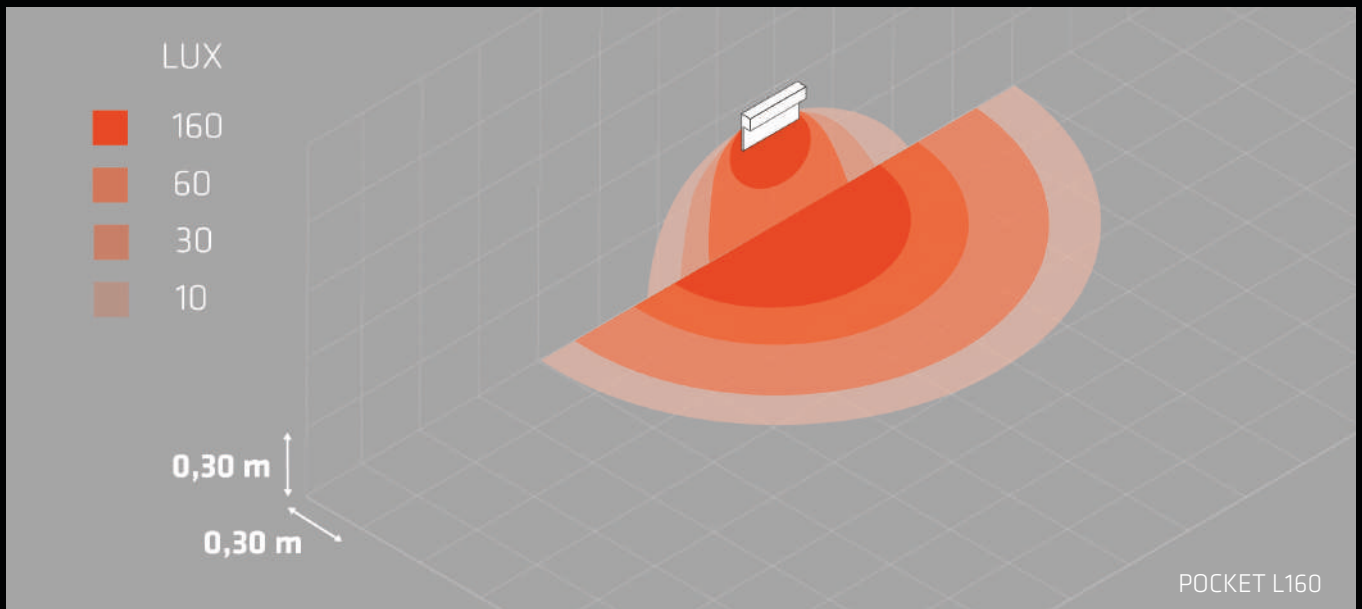
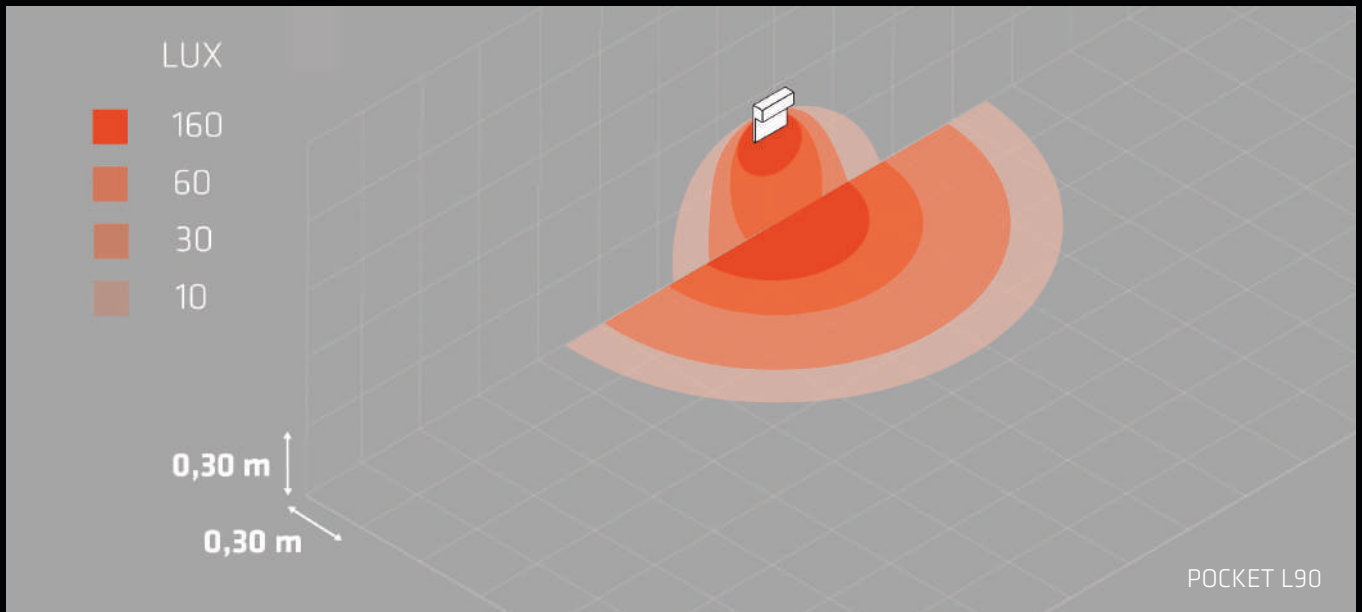

# POCKET

collection

Augenti®

11/pocket WALL RECESSED

# POCKET

collection





**Augenti**

13/pocket WALL RECESSED

**POCKET**

GOOD

INSTALLATION

BY **Augenti**<sup>®</sup>  
LIGHTING







# Augenti<sup>®</sup>

LIGHTING



**AUGENTI LIGHTING S.R.L.** UNIPERSONALE

Via Francesco Lana, 31 - 25065 Lumezzane (BS) Italy - tel: (+39) 030 7282524 - fax: (+39) 030 7281879  
info@augentilighting.it - www.augentilighting.it